

AQUAGEM[®]

Enjoy the silence

INVERTER POOL PUMP



INSTALLATION & OPERATION MANUAL

CONTENTS

1. ⚠ IMPORTANT SAFETY INSTRUCTIONS	2
2. TECHNICAL SPECIFICATIONS.....	3
3. OVERALL DIMENSION	3
4. INSTALLATION.....	3
5. SETTING AND OPERATION.....	6
6. EXTERNAL CONTROL	8
7. PROTECTION AND FAILURE.....	10
8. MAINTENANCE.....	12
9. WARRANTY & EXCLUSIONS.....	12
10. DISPOSAL.....	13

THANK YOU FOR PURCHASING OUR INVERTER POOL PUMPS.

THIS MANUAL CONTAINS IMPORTANT INFORMATION THAT WILL HELP YOU IN OPERATING AND MAINTAINING THIS PRODUCT

PLEASE READ THE MANUAL CAREFULLY BEFORE INSTALLATION & OPERATION AND RETAIN IT FOR FUTURE REFERENCE

1. IMPORTANT SAFETY INSTRUCTIONS

This guide provides installation and operation instructions for this pump. If you have any other questions about this equipment, please consult your supplier.

1.1 When installing and using this electrical equipment, basic safety precautions should always be followed, including the following:

- **RISK OF ELECTRICAL SHOCK.** Connect only to a branch circuit protected by a ground-fault circuit-interrupter (GFCI). Contact a professionally trained and qualified electrician if you cannot verify that the circuit is protected by a GFCI.
- This pump is for use with permanently installed in-ground or above-ground swimming pools and may also be used with hot tubs and spas with a water temperature under 50°C. Do not use on above-ground pools that can be readily disassembled for storage.
- The pump is not submersible.
- Before servicing the pump, please switch off power to the pump by disconnecting the main circuit to the pump.
- Never open the inside of the drive motor enclosure.

1.2 All installations must be fitted with earth leakage or residual current protection devices, having a rated residual operating current not exceeding 30mA.

WARNING:

- Fill the pump with water before starting. Do not run the pump dry. In case of dry run, mechanical seal will be damaged and the pump will start leaking.
- Before servicing the pump, switch OFF power to the pump by disconnecting the main circuit to the pump and release all pressure from pump and piping system.
- Never tighten or loosen screws while the pump is operating.
- Ensure that the inlet and outlet of the pump are unblocked with foreign matter.

2. TECHNICAL SPECIFICATIONS

Model	Advised Pool Volume (m ³)	P1	Voltage (V/Hz)	Qmax (m ³ /h)	Hmax (m)	Circulation (m ³ /h)	
		KW				At 8m	At 10m
IP20	30~50	0.09~0.84	220~240 / 50/60	24.5	12	6~20	6~14
IP25	40~70	0.09~1.1		27	15	6~25	6~21
IP30	50~80	0.09~1.4		31.0	18	9.4~31	12.1~29
IP40	70~100	0.1~1.8		41	17	12~40	16~37

3. OVERALL DIMENSION (mm)

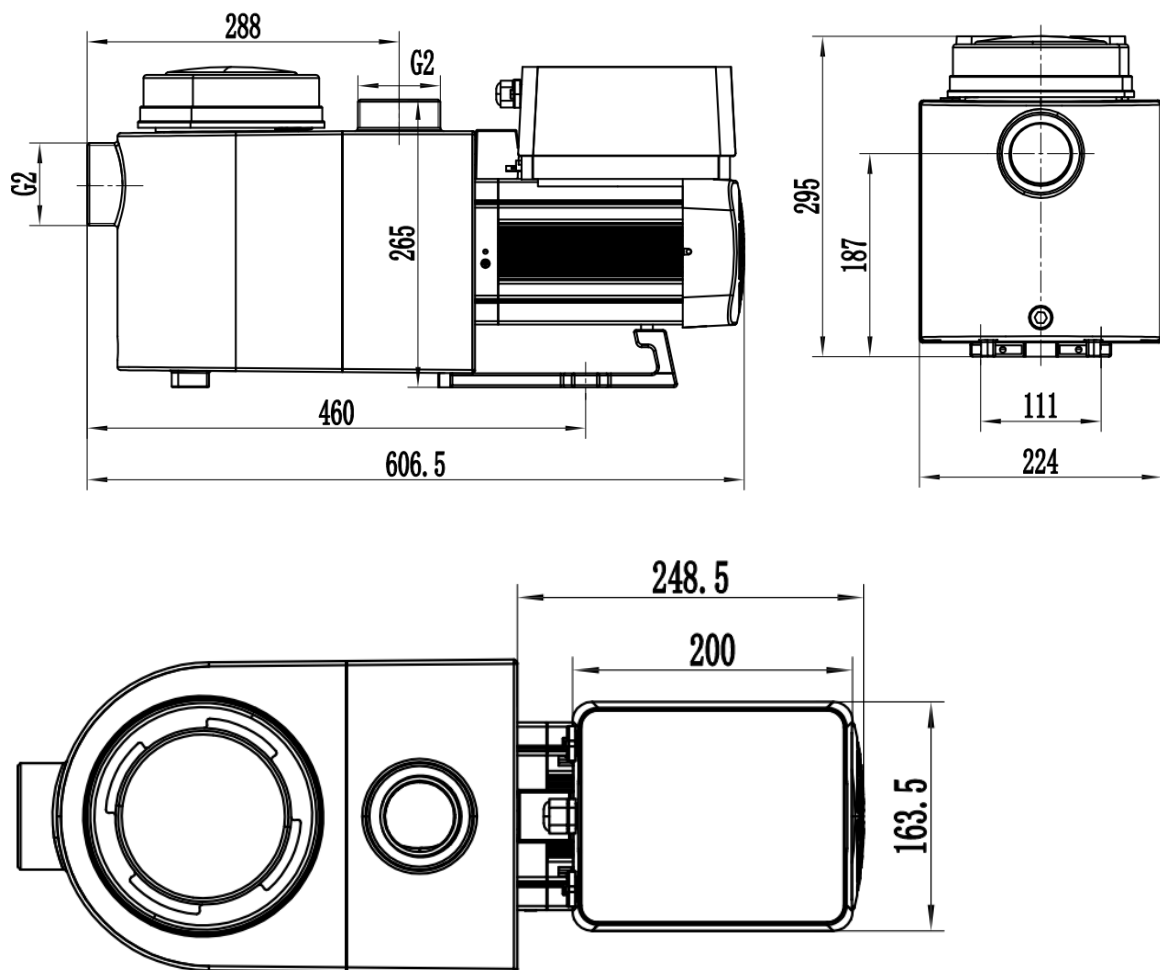

Figure 1

4. INSTALLATION

4.1. Pump Location

- 1) Install the pump as close to the pool as possible. To reduce friction loss and improve efficiency, use short, direct suction and return piping.
- 2) To avoid direct sunshine or heat. It is recommended to place the pump indoors or in the shade.
- 3) DO NOT install the pump in a damp or non-ventilated location. Keep pump and motor at least 150mm away from obstacles, pump motors require free circulation of air for cooling.
- 4) The pump should be installed horizontally and fixed in the hole on the support with screws to prevent unnecessary noise and vibration.

4.2. Piping

- 1) For improved pool plumbing, it is recommended to use a larger pipe size. When installing the inlet and outlet fittings (joints), use the special sealant for PVC material.
- 2) Piping on the suction side of the pump should be the same or larger than the inlet line diameter, to avoid pump sucking air, which will affect the efficiency of the pump.
- 3) Plumbing on the suction side of the pump should be as short as possible.
- 4) For most installations we recommend installing a valve on both the pump suction and return lines, which is more convenient for routine maintenance. However, we also recommend that a valve, elbow, or tee installed on the suction line should be no closer to the front of the pump than five times the suction line diameter.
- 5) Pump outlet piping system should be equipped with a check valve to prevent the pump from the impact of medium recirculation and pump-stopping water hammer.

4.3. Valves and Fittings

- 1) Elbows should be no closer than 350mm to the inlet. Do not install 90° elbows directly into the pump inlet/outlet. Joints must be tight.

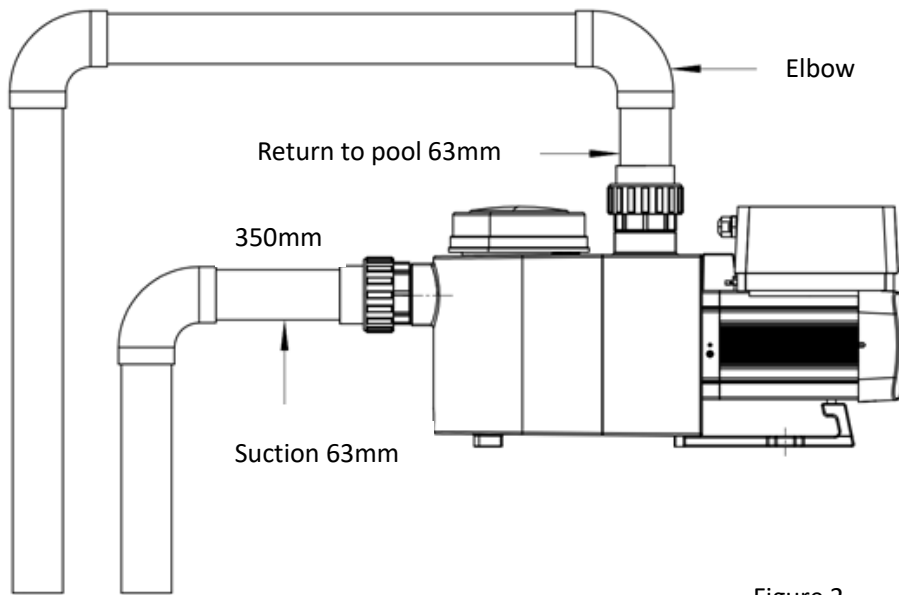

Figure 2

* The pump inlet/outlet union size: 1-1/2", 2" or Dn50/63 optional.

2) Flooded suction systems should have gate valves installed on suction and return line for maintenance; however, the suction gate valve should be no closer than five times the suction pipe diameter as described in this section.

3) Use a check valve in the return line when using this pump for any application where there is significant height to the outlet of the pump.

4) Be sure to install check valves when plumbing in parallel with other pumps. This helps prevent reverse rotation of the impeller and motor.

4.4 Check before initial startup

- 1) Check whether pump shaft rotates freely;
- 2) Check whether power supply voltage and frequency conform to the nameplate;
- 3) Facing fan blade, the direction of motor rotation is clockwise;
- 4) It is forbidden to run the pump without water.

4.5 Application conditions



Ambient temperature	Indoor installation, temperature range: -10°C~50°C
Salt pools	No greater than 0.5%
Humidity	≤90% RH, (20°C±2°C)
Altitude	Not exceed 1000m above sea level
Suction Height	2m
Insulation	Class F, IP55

5. SETTING AND OPERATION



5.1 Display on control panel:

<p>The control panel features a digital display with several indicators and buttons. At the top, it shows '1200w' (power consumption), '80%' (running capacity), and a timer '88:88-88:88'. A unit selection menu is visible on the right, listing 'IMP gpm', 'L/min', 'US gpm', and 'm³/h'. Below the display are five navigation buttons (backwash/unlock, up/down, mode, down, timer) and a power button.</p>	① Power consumption
	② Running capacity / Flow rate
	③ Wifi indicator
	④ Unit of flow
	⑤ Timer period
	⑥ Timer 1/2/3/4
	Backwash/unlock
	Up/down: to change the value (capacity/flow/time)
	Icon for Auto-Inverter Mode/Manual-Inverter Mode Auto-Inverter Mode: The pump's running capacity be automatically adjusted between 20%-100% according to the setting flow. Manual-Inverter Mode: The pump's running capacity be set manually between 20%-100% The default mode is Manual-Inverter mode.
	Timer setting
On/off	











5.2 Priming

When the pump starts at the first time, the system performs the priming procedure. The running capacity will go up from 20% to 100% by 5% each step, then runs at 100% with default period and count down in 180 seconds. The time could be set from 0~900 seconds, by pressing  or . When priming is completed or set to be 0 second, the capacity will be reduced slightly from 100% to 80% by 5% per second.

To disable self-priming, press and hold  for 3 seconds, the pump will pass to normal operation mode with running capacity at 80%.









Note: If the selfpriming time is set to 0 second, it will be stored. When you press  to backwash in future, please press  to increase the time for backwash.

5.3 Manual-Inverter Mode

1		Press > 3 seconds to unlock the screen; Press < 3 seconds for backwash mode; Under backwash mode, pump will count down in 180 seconds, Press  or  to adjust backwash time from 0~900 seconds.
2		Press the icon to start. The pump will run at 80% after priming.
3	 	The running capacity could be adjusted from 20% ~ 100%, by pressing  or  .
4		Press  > 3 seconds, to check the instant flow of the running capacity, the flow rate will display for 10 seconds.











5.4 Auto-Inverter Mode

According to the set water flow, the pump could automatically detect the system pressure to adjust the speed of motor, to ensure a constant flow.



1		Unlock the screen, press  to shift from the Manual-Inver mode to Auto-Inverter mode.
2	 	Press  or  to set the flow rate, each step by 1m ³ /h, Flow range (IP25 for example) : 5~28 m ³ /h; the default flow is 20m ³ /h.
3		Press  again to exit Auto-Inverter mode.

5.5 Timer mode









The pump's on/off and running capacity could be commanded by timer, which could be programmed daily as needed.

1. Enter timer setting	
2. Set current time	 or 
3. Confirm and move to next step	
4. Decide the specific capacity or flow	 or 
5. Repeat above steps to set other 3 timers	
6. Hold 3 seconds to save setting	
7. Check 4 timers to make sure there is no invalid setting	 or 

Note: Overlap setting of time will be considered as invalid, the pump will only run based on the previous valid setting.

During timer setting, if you want to return to the previous setting, hold both   for 3 seconds.

5.6 Parameter Setting

Restore factory setting	Under off mode, hold both   for 3 seconds
Checking the version of software	Under off mode, hold both   for 3 seconds
Enter parameter setting as below	Under off mode, hold both   for 3 seconds; If no adjustment for address 1, hold both   to next address

Address	Description	Default Setting	Setting Range
1	Di2	100%	20~100%, by 5% increments
2	Di3	80%	20~100%, by 5% increments
3	Di4	40%	20~100%, by 5% increments
4	Self-priming/ Backwash capacity	100%	80~100%, by 5% increments
5	Control mode of Analog Input	0	0: current control 1: Voltage control

6. EXTERNAL CONTROL

External control can be enabled via following contacts. If more than one external control is enabled, the priority is as below: Digital Input > Analog Input > RS485 > Panel control

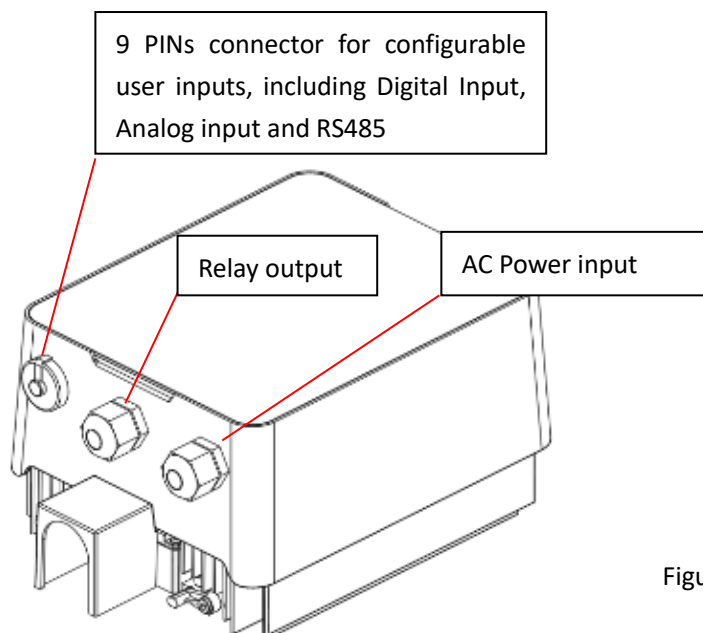

Figure 4

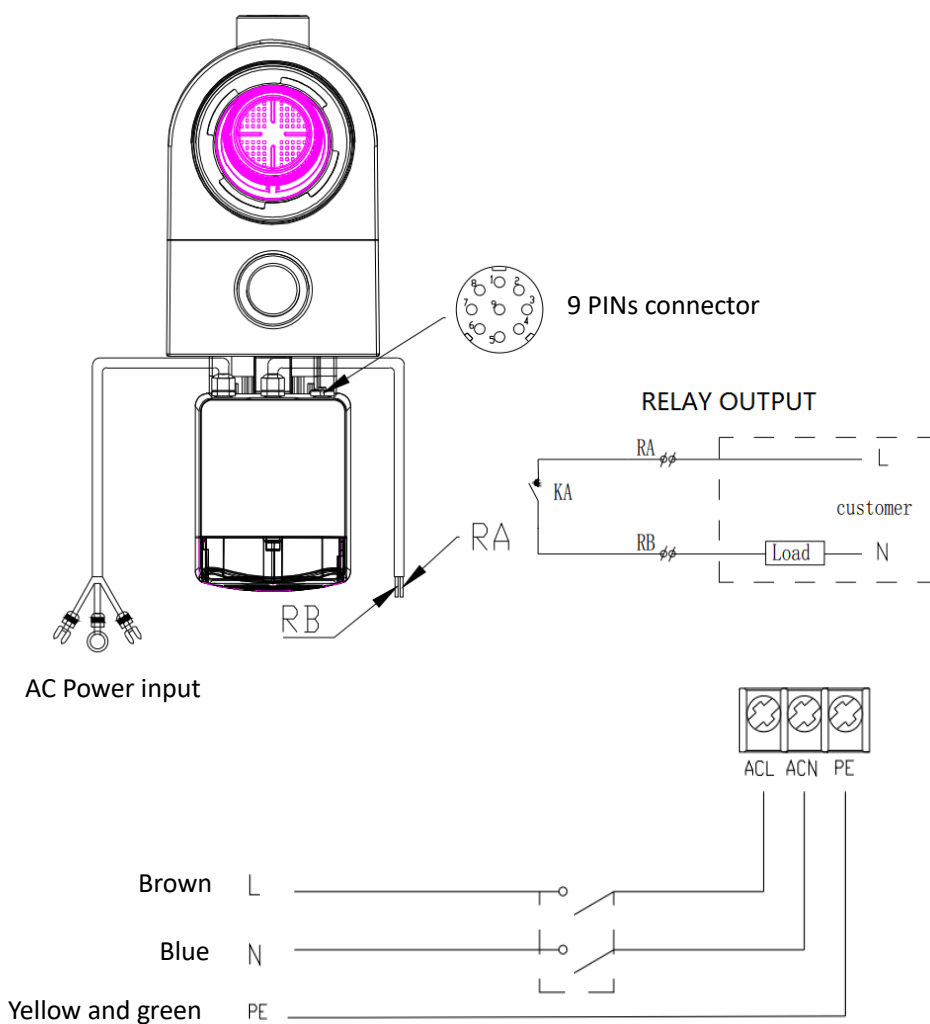

Figure 5

Name	Color	Description
PIN 1	Red	Digital Input 4
PIN 2	Black	Digital Input 3
PIN 3	White	Digital Input 2
PIN 4	Grey	Digital Input 1
PIN 5	Yellow	Digital Ground
PIN 6	Green	RS485 A
PIN 7	Brown	RS485 B
PIN 8	Blue	Anolog Input 0 (0-10V or 0~20mA)
PIN 9	Orange	Analog Ground

a. Digital input:

Running capacity determined by the state of digital input,
When **PIN4** connect with PIN5, it means the pump stop running;
When **PIN3** connect with PIN5, the pump runs at 100%;
When **PIN2** connect with PIN5, the pump runs at 80%;
When **PIN1** connect with PIN5, the pump runs at 40%;
Capacity of inputs (**PIN1/PIN2/PIN3**) could be modified according to the parameter setting.

b. Analog Input:

To connect with PIN 8 and PIN 9, running capacity could be determined by 0~10V analog voltage signal or 0~20 mA analog current signal.
Capacity to be controlled by voltage or current could be set according to the parameter setting

c. RS485:

To connect with PIN6 and PIN7, the pump could be controlled via Modbus 485 communication protocol.

d. Relay output (optional):

Connect terminal L & N to enable external control. An additional on-off Relay is necessary while bearing power is greater than 500W (2.5A).

7. PROTECTION AND FAILURE

Problem	Corrective solution
Pump Does Not Start	<ul style="list-style-type: none">• Power Supply fault, disconnected or defective wiring.• Fuses blown or thermal overload open.• Check the rotation of the motor shaft for free movement and lack of obstruction.• Because of long time lying idle. Unplug the power supply and manually rotate motor rear shaft a few times with a screwdriver.
Pump Won't Prime	<ul style="list-style-type: none">• Empty pump/strainer housing. Make sure the pump/strainer housing is filled with water and the O ring of cover is clean.• Loose connections on the suction side.• Strainer basket or skimmer basket loaded with debris.• Suction side clogged.• Distance between pump inlet and liquid level is higher than 2.5m, height of pump installation should be lowered.

Low Water Flow	<ul style="list-style-type: none"> • Pump is not primed. • Air entering suction piping. • Basket full of debris. • Inadequate water level in pool.
Pump being noisy	<ul style="list-style-type: none"> • Air leak in suction piping, cavitation caused by restricted or undersized suction line or leak at any joint, low water level in pool, and unrestricted discharge return lines. • Vibration caused by improper installation, etc. • Damaged motor bearing or impeller (need to contact the supplier for repair).

7.1 Error code

When the device detects a failure (except for the running capacity reduction strategy and 485 communication failure), it will power off automatically and display the failure code. After power off for 15 seconds, check if the failure is cleared, if cleared, it will resume to start.

Item	Error Code	Description
1	E001	Abnormal input voltage
2	E002	Output over current
3	E101	Heat sink over heat
4	E102	Heat sink sensor error
5	E103	Master driver board error
6	E104	Phase-deficient protection
7	E105	AC current sampling circuit failure
8	E106	DC abnormal voltage
9	E107	PFC protection
10	E108	Motor power overload
11	E201	Circuit board error
12	E202	Master board EEPROM reading failure
13	E203	RTC time reading error
14	E204	Display Board EEPROM reading failure
15	E205	Communication Error
16	E206	RS485 communication Error
17	E207	Low water level

Note:

1. When causes for E002/E101/E103 is displayed, the device will resume working automatically, however when it appears a fourth time, the device will stop working, to resume operation, unplug the device and plug in & restart again.

8. MAINTENANCE

Emptying the strainer basket, the basket should be inspected frequently through the transparent lid and emptied when a build-up of rubbish is evident. The following instructions should be followed:

1. Disconnected the power supply.
2. Unscrew the strainer basket lid anti-clockwise and remove.
3. Lift up the strainer basket.
4. Empty the trapped refuse from the basket, rinse out the debris if necessary.

Note: Do not knock the plastic basket on a hard surface as it will cause damage

5. Inspect the basket for signs of damage, replace it.
6. Check the lid O-ring for stretching, tears, cracks or any other damage
7. Replace the lid, hand tightening is sufficient.

Note: Periodically inspect and clean the strainer basket will help prolong its life.

9. WARRANTY & EXCLUSIONS

Should a defect become evident during the term of warranty, at its option, the manufacturer will repair or replace such item or part at its own cost and expense. Customers need to follow the warranty claim procedure in order to obtain the benefit on this warranty.

The guarantee will be void in cases of improper installation, improper operation, inappropriate use, tampering or using non-original spare parts.

10. DISPOSAL



When disposing the product, please sort the waste products as electrical or electronic product waste or hand it over to the local waste collection system.

The separate collection and recycling of waste equipment at the time of disposal will help ensure that it is recycled in a manner that protects human

health and the environment. Contact your local authority for information on where you can drop off your waste for recycling.

